

Project: DEVELOP
 Time Now: 01/01/2003
 Start: 01/01/2003
 Finish: 10/16/2007
 Run: 04/12/2006

SOFTWARE FOR DEMONSTRATION
 PURPOSES ONLY
 Develop an Application

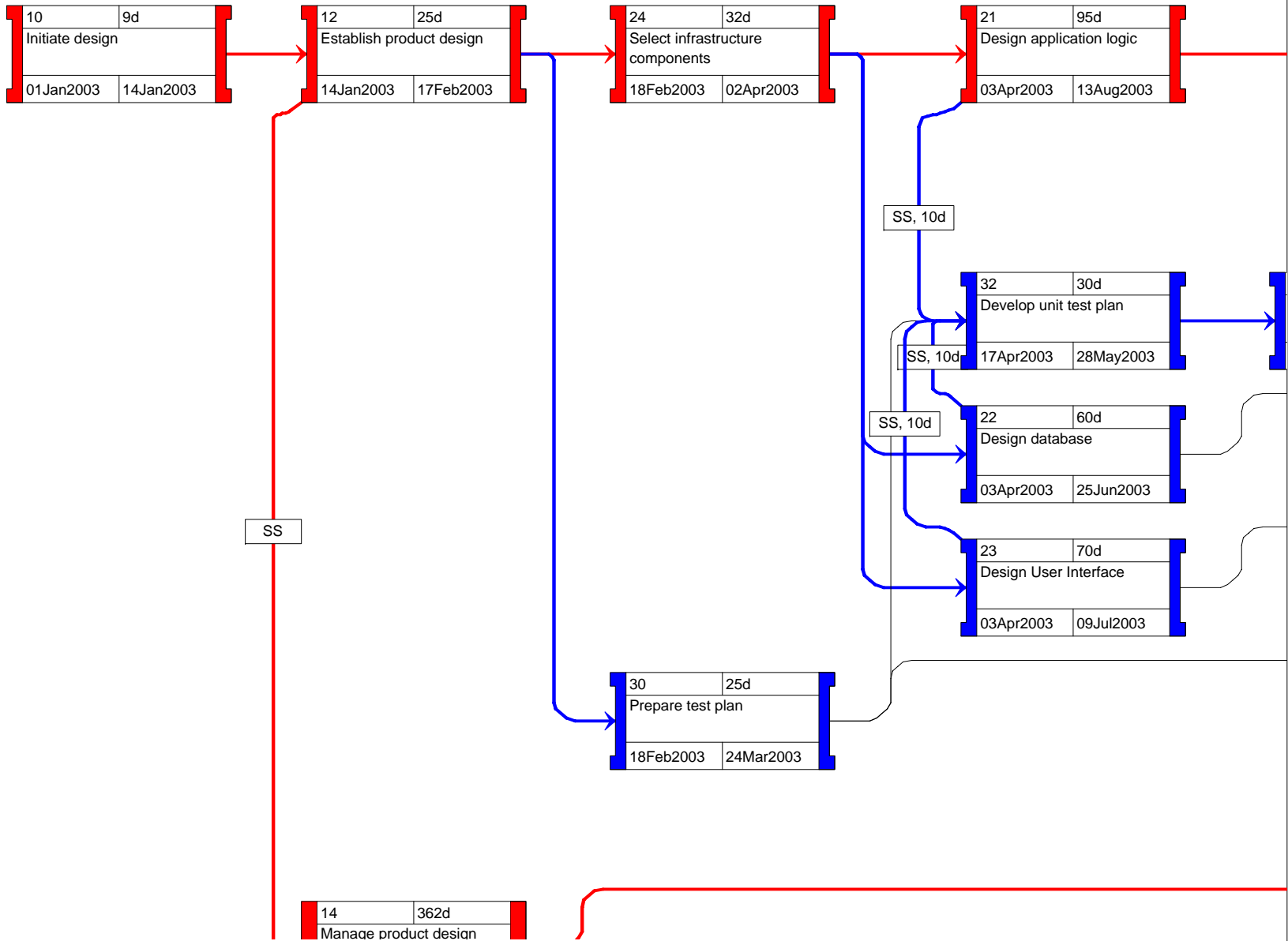

Project: DEVELOP
Time Now: 01/01/2003
Start: 01/01/2003
Finish: 10/16/2007
Run: 04/12/2006

SOFTWARE FOR DEMONSTRATION
PURPOSES ONLY
Develop an Application

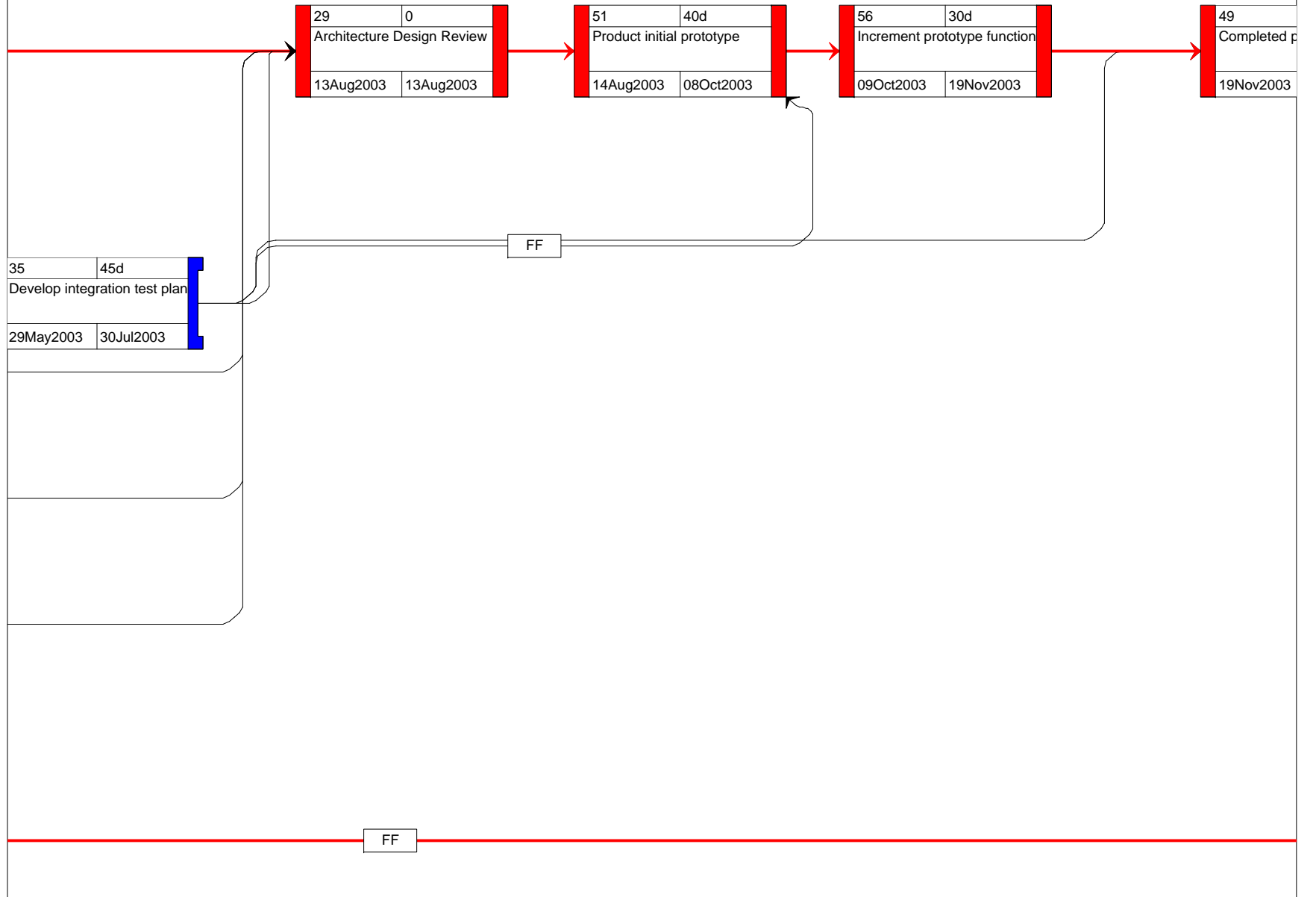

Project:	DEVELOP	SOFTWARE FOR DEMONSTRATION
Time Now:	01/01/2003	PURPOSES ONLY
Start:	01/01/2003	Develop an Application
Finish:	10/16/2007	
Run:	04/12/2006	

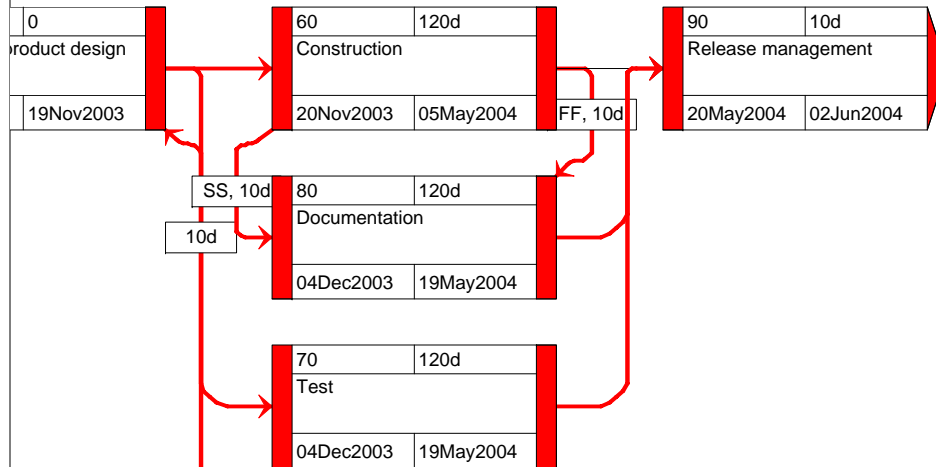

Project: DEVELOP
Time Now: 01/01/2003
Start: 01/01/2003
Finish: 10/16/2007
Run: 04/12/2006

SOFTWARE FOR DEMONSTRATION
PURPOSES ONLY
Develop an Application

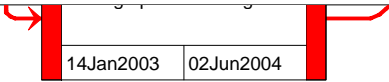

Project:	DEVELOP	SOFTWARE FOR DEMONSTRATION
Time Now:	01/01/2003	PURPOSES ONLY
Start:	01/01/2003	Develop an Application
Finish:	10/16/2007	
Run:	04/12/2006	

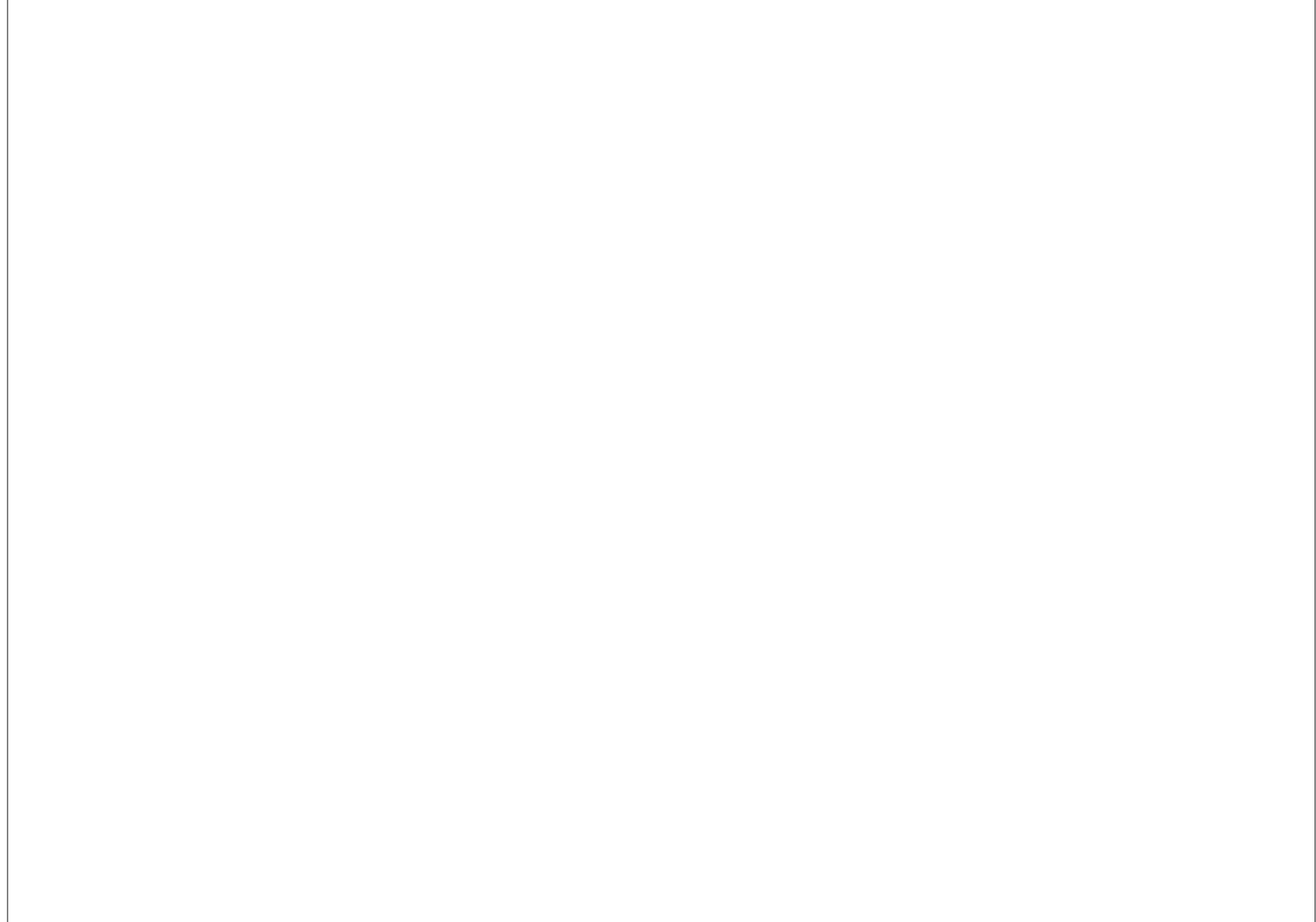

Project:	DEVELOP	SOFTWARE FOR DEMONSTRATION
Time Now:	01/01/2003	PURPOSES ONLY
Start:	01/01/2003	Develop an Application
Finish:	10/16/2007	
Run:	04/12/2006	



1	Activity ID
2	Original Duration
3	Activity Desc.
4	Early Start
5	Early Finish

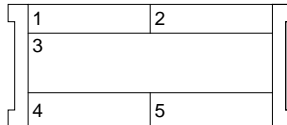

Subproject

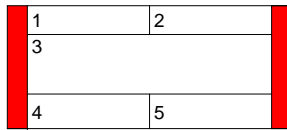

Critical_Activity

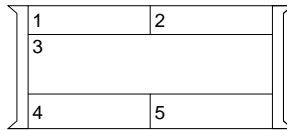

External_Subproject

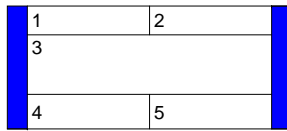

Non-Critical

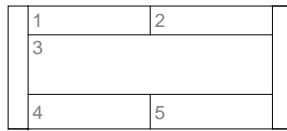

Foreign_Activity

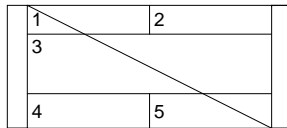

In-Progress

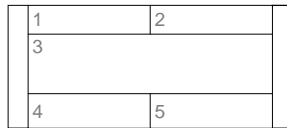

Foreign_Subproject

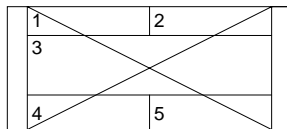

Complete

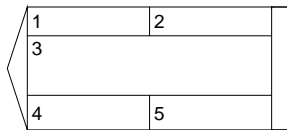

Start_Activity

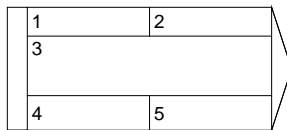

End_Activity

Project:	DEVELOP	SOFTWARE FOR DEMONSTRATION
Time Now:	01/01/2003	PURPOSES ONLY
Start:	01/01/2003	Develop an Application
Finish:	10/16/2007	
Run:	04/12/2006	

Project: DEVELOP, Develop an Application

Category: < Default >, Modified by: GUEST, Date: 12Apr2006.

This project is defined as a rolling wave project.

Near term work packages (within 6-8 months) are defined in detail. Future phases are defined at a planning package level only at this time.